

**WIPER MOTORS**



**WIPER COMPLETE KITS**



**WHEEL BOXES**



**WIPER ARMS**



**WASHER TANKS**



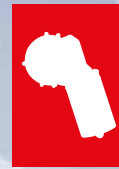

### 180W

APPLICATIONS:

**BUS  
(BIG  
WINDSHIELD)**

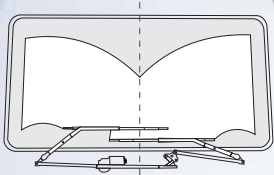

NOMINAL TORQUE	20 Nm	STALL TORQUE	130 Nm	DRIVE SHAFT	13.26 mm
----------------	-------	--------------	--------	-------------	----------

MRP (EACH)	PART NO.	VEHICLE MFGR	VEHICLE MODEL MOTOR SPECIFICATIONS
	WM-512	TATA/LEYLAND	180W 24V (HIGH POWER)
	WM-513	TATA/LEYLAND	180W 12V (HIGH POWER)



### 120W

APPLICATIONS:

**BUS  
(MID SEGMENT)**

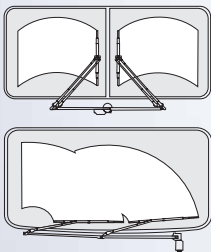

NOMINAL TORQUE	15 Nm	STALL TORQUE	80 Nm	DRIVE SHAFT	13.26 mm
----------------	-------	--------------	-------	-------------	----------

MRP (EACH)	PART NO.	VEHICLE MFGR	VEHICLE MODEL MOTOR SPECIFICATIONS
	WM-514	LEYLAND/TATA	120W 24V (HIGH POWER)
	WM-515	LEYLAND/TATA	120W 12V (HIGH POWER)



### 50W

APPLICATIONS:

**SCHOOL BUS,  
STAFF BUS,  
&  
HCV TRUCK**

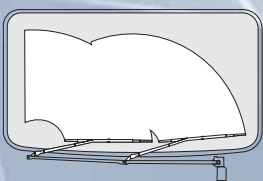

NOMINAL TORQUE	10 Nm	STALL TORQUE	35 Nm	DRIVE SHAFT	M8 TAPER
----------------	-------	--------------	-------	-------------	----------

MRP (EACH)	PART NO.	VEHICLE MFGR	VEHICLE MODEL MOTOR SPECIFICATIONS
	WM-516	TATA	50W 12V (LCV SKOOL BUS/MARCOPOLO ULTRA BUS)
	WM-517	TATA	50W 24V (PRIMA/MAN/MARCOPOLO ULTRA BUS)



APPROVED AS ORIGINAL EQUIPMENT BY LEADING INDIAN & OVERSEAS VEHICLE MANUFACTURERS



### 17W

APPLICATIONS:

TRUCK  
&  
LCV

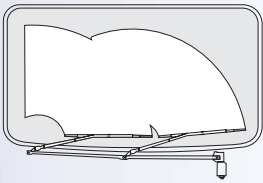

NOMINAL TORQUE	5 Nm	STALL TORQUE	20 Nm	DRIVE SHAFT	6mm PIN
----------------	------	--------------	-------	-------------	---------

NOMINAL TORQUE	7 Nm	STALL TORQUE	24 Nm	DRIVE SHAFT	8mm PIN
----------------	------	--------------	-------	-------------	---------

MRP (EACH)	PART NO.	VEHICLE MFGR	VEHICLE MODEL MOTOR SPECIFICATIONS
	WM-502	TATA/LEYLAND	17W DOUBLE SPEED 12v 6mm PIN
	WM-503	TATA/LEYLAND	17W DOUBLE SPEED 24v 6mm PIN
	WM-504	TATA	1210SE/1313/1613 12v 6mm PIN
	WM-505	TATA	1210SE/1313/1613 24v 6mm PIN
	WM-506	TATA	407/608 12v 8mm PIN
	WM-507	TATA	407/608 24v 8mm PIN
	WM-508	TATA	613/709 12v 8mm PIN
	WM-509	TATA	613/709 24v 8mm PIN
	WM-510	TATA	3516/4018 12v 6mm PIN
	WM-511	TATA	3516/4018 24v 6mm PIN



### 60W

APPLICATIONS:

BUS  
(PMPL/BMTC)

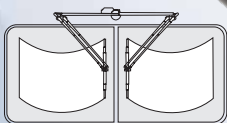

NOMINAL TORQUE	15 Nm	STALL TORQUE	50 Nm	DRIVE SHAFT	11.26 mm
----------------	-------	--------------	-------	-------------	----------

MRP (EACH)	PART NO.	VEHICLE MFGR	VEHICLE MODEL MOTOR SPECIFICATIONS
	WM-518	MARCOPOLO	60W 12V TOP MOUNTING(RGB)



### 30W

APPLICATIONS:

CAR, SUV & UV

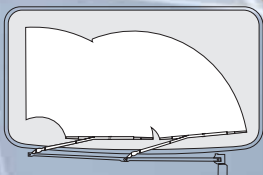
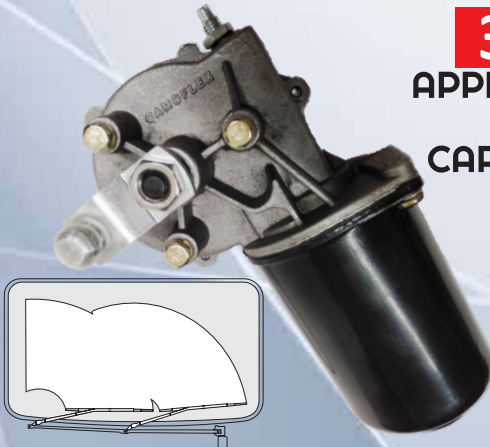

NOMINAL TORQUE	5 Nm	STALL TORQUE	20 Nm	DRIVE SHAFT	M6 TAPER
----------------	------	--------------	-------	-------------	----------

MRP (EACH)	PART NO.	VEHICLE MFGR	VEHICLE MODEL MOTOR SPECIFICATIONS
	WM-519	MAHINDRA	BOLERO 12v (4PIN CONNECTOR)
	WM-520	MAHINDRA	BOLERO 12v (5PIN CONNECTOR)





**14W**

**APPLICATIONS:**  
3 WHEELER & UV



NOMINAL TORQUE	4 Nm	STALL TORQUE	15 Nm	DRIVE SHAFT	RACK PINION
MRP (EACH)	PART NO.	VEHICLE MFGR	VEHICLE MODEL MOTOR SPECIFICATIONS		
	WM-521	PIAGGIO/ATUL	14W 12v PIAGGIO/ATUL/JS AUTO		



**10W**

**APPLICATIONS:**  
3 WHEELER & E-VEHICLE

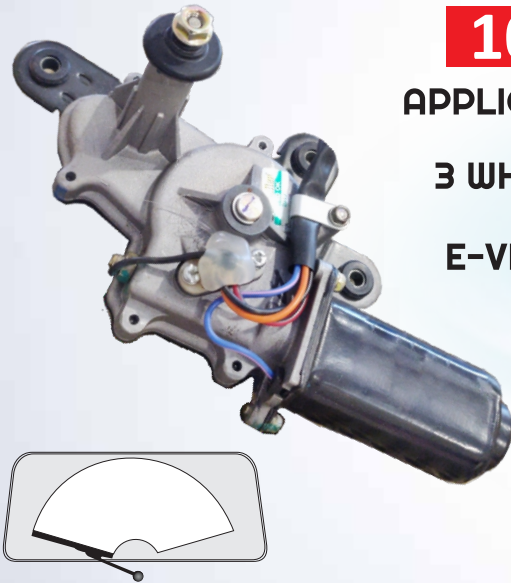

NOMINAL TORQUE	3 Nm	STALL TORQUE	9 Nm	DRIVE SHAFT	M5 TAPER
MRP (EACH)	PART NO.	VEHICLE MFGR	VEHICLE MODEL MOTOR SPECIFICATIONS		
	WM-527	BAJAJ	12V SINGLE CURVED GLASS		



**25W**

**APPLICATIONS:**  
HYDRA, EARTHMOVER & 3WHEELER

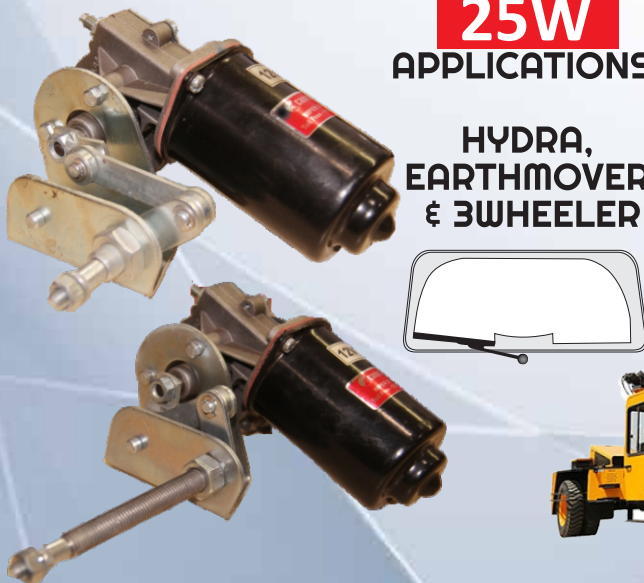

NOMINAL TORQUE	5 Nm	STALL TORQUE	20 Nm	DRIVE SHAFT	M6 TAPER
MRP (EACH)	PART NO.	VEHICLE MFGR	VEHICLE MODEL MOTOR SPECIFICATIONS		
	WM-525	ACE/ECL	12v ACTION/ESCORTS HYDRA (LONG SHAFT)		
	WM-526	ACE/ECL	12v ACTION/ESCORTS FN (SHORT SHAFT)		
	WM-522	SCOOTERS IND	12v HANDLE BAR MODEL		
	WM-523	SCOOTERS IND	12v STEERING MODEL		



APPROVED AS ORIGINAL EQUIPMENT BY LEADING INDIAN & OVERSEAS VEHICLE MANUFACTURERS



**SMALL SHAFT W/O BUSH ASSEMBLY**  
WL-101



**BIG SHAFT ASSY/TATA 407**  
WL-102



**SMALL SHAFT WITH BUSH SPACER ASSEMBLY**  
WL-103



**PENTOGRAPH SMALL SHAFT WITH BUSH**  
WL-104



**PENTOGRAPH SMALL SHAFT W/O BUSH**  
WL-105



**TATA 3516/4018**  
WL-106

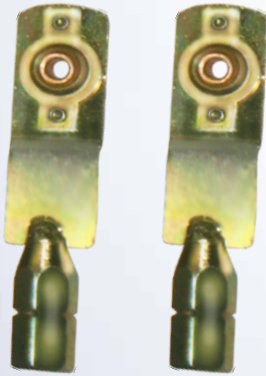

**HEX LINK ASSEMBLY (SET OF 2)**  
WL-107



**LEYLAND 4921/STAG BUS**  
WL-108



**TATA SIGNA**  
WL-109



**VOLVO SPINDLE (MAOYI)(ORIGINAL)(SET OF 2)**  
WL-110



**ACGL PENTO SPINDLE(BEST/PMPL)(SET OF 2)**  
WL-112



**ACGL COMFORT (ORIGINAL)(SET OF 2)**  
WL-113

**VOLVO SPINDLE (DOGA)(ORIGINAL)(SET OF 2)**  
WL-111

**VOLVO TYPE SPINDLE (M12)(SET OF 2)**  
WL-114





HEIGHT-205mm  
WIDTH-130mm  
DEPTH-100mm

**1L TANK WITH REAR BRACKET ASSY 12v/24v (OPTIONAL)**

**WT-700**



HEIGHT-180mm  
WIDTH-175mm  
DEPTH-100mm

**1.5L TANK WITH BOTH SIDE HOLES 12v/24v (OPTIONAL)**

**WT-701**

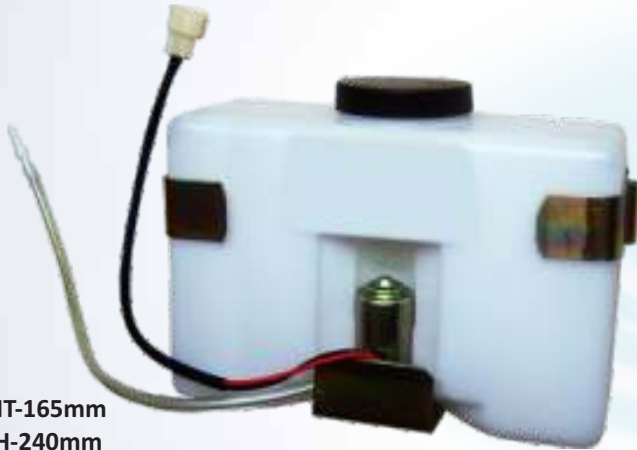

HEIGHT-165mm  
WIDTH-240mm  
DEPTH-100mm

**3.5L TANK WITH BRACKET ASSY 12V/24V (OPTIONAL)**

**WT-702**



HEIGHT-230mm  
WIDTH-210mm  
DEPTH-95mm

**3L TANK WITH BOTH SIDE HOLES 12v/24v (OPTIONAL)**

**WT-703**



HEIGHT-310mm  
WIDTH-330mm  
DEPTH-127mm

**10L TANK WITH 2 PUMPS 12V/24V (OPTIONAL)**

**WT-704**

CAPACITY- 2 LITRE/MIN  
CURRENT- 2-3amps



METAL CASE WASHER PUMP 12v

**WM-402**

METAL CASE WASHER PUMP 24v

**WM-403**

CAPACITY- 2 LITRE/MIN  
CURRENT- 2-3amps



PLASTIC CASE WASHER PUMP 12v

**WM-400**

PLASTIC CASE WASHER PUMP 24v

**WM-401**



**APPROVED AS ORIGINAL EQUIPMENT BY LEADING INDIAN & OVERSEAS VEHICLE MANUFACTURERS**

# camoflex<sup>®</sup>

## WIPER SYSTEMS



**OPPOSED  
WIPER  
SYSTEMS**

**12V/24V**

AVAILABLE

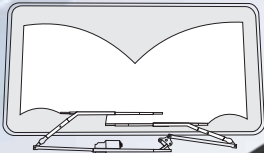

SUITABLE

180W

3L



1000mm



1000mm

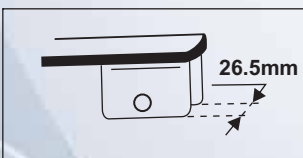
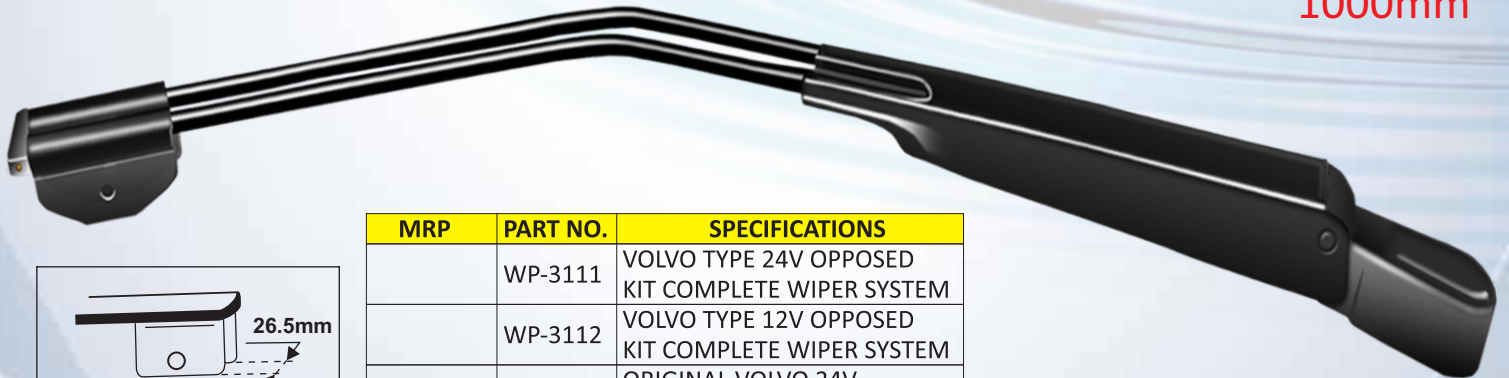

**WIPER ARM  
CLAMP INNER  
WIDTH**

MRP	PART NO.	SPECIFICATIONS
	WP-3111	VOLVO TYPE 24V OPPOSED KIT COMPLETE WIPER SYSTEM
	WP-3112	VOLVO TYPE 12V OPPOSED KIT COMPLETE WIPER SYSTEM
	WP-3114	ORIGINAL VOLVO 24V (AS PER ORG CHINESE KIT)
	WP-3115	ORIGINAL VOLVO 24V (AS PER ORG DOGA KIT)
	WP-3117	ALL BODY BUILDERS SPECIAL KITS 24V/12V (INCLUDES ALL OEMS/BODYBUILDERS)



AVAILABLE  
(OPTIONAL)

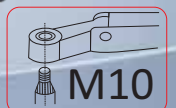

AVAILABLE  
(OPTIONAL)

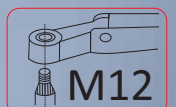

APPROVED AS ORIGINAL EQUIPMENT BY LEADING INDIAN & OVERSEAS VEHICLE MANUFACTURERS



# camoflex<sup>®</sup>

## WIPER SYSTEMS



# PENTOGRAPH WIPER SYSTEM



**12V/24V**

AVAILABLE

120W

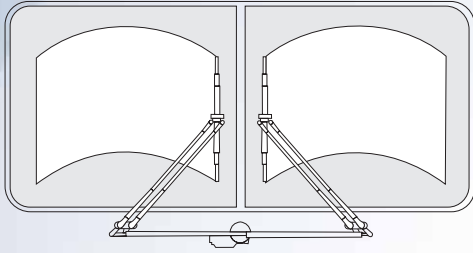

SUITABLE



3L



MRP	PART NO.	SPECIFICATIONS
	WP-3116	PENTOGRAPH 12V/24V FOR BEST PMPL COMPLETE WIPER SYSTEM

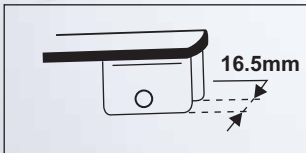

WIPER ARM  
CLAMP INNER  
WIDTH

AVAILABLE  
(OPTIONAL)

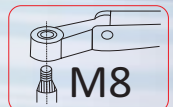

AVAILABLE  
(OPTIONAL)

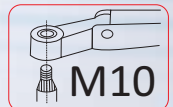

700mm

700mm

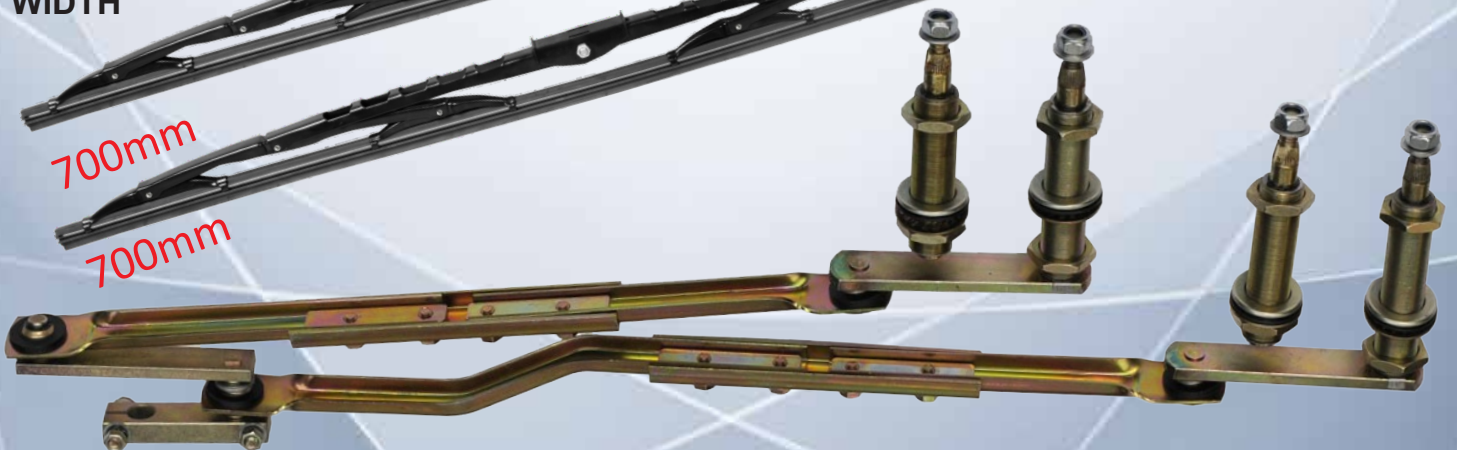

APPROVED AS ORIGINAL EQUIPMENT BY LEADING INDIAN & OVERSEAS VEHICLE MANUFACTURERS



# camoflex<sup>®</sup>

## WIPER SYSTEMS



### RADIAL WIPER SYSTEM

**12V/24V**

AVAILABLE

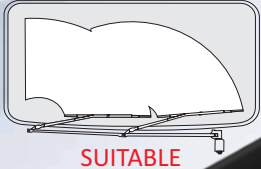

SUITABLE

**180W**

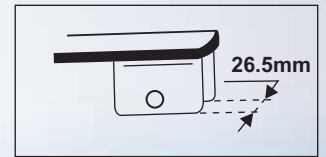

WIPER ARM  
CLAMP INNER  
WIDTH

3L



800mm/1000mm

800mm/1000mm

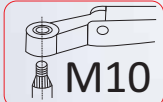

AVAILABLE  
(OPTIONAL)

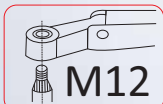

AVAILABLE  
(OPTIONAL)



MRP	PART NO.	SPECIFICATIONS
	WP-3113	VOLVO TYPE 24V RADIAL KIT COMPLETE WIPER SYSTEM

APPROVED AS ORIGINAL EQUIPMENT BY LEADING INDIAN & OVERSEAS VEHICLE MANUFACTURERS



# camoflex<sup>®</sup>

## WIPER SYSTEMS



### RADIAL WIPER SYSTEM

**12V/24V**

AVAILABLE

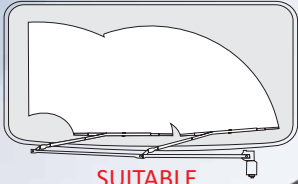

SUITABLE

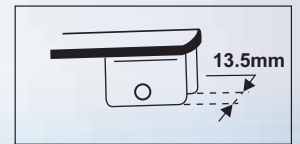

WIPER ARM  
CLAMP INNER  
WIDTH



50W



1L

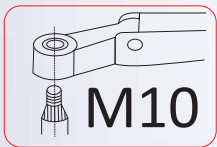

AVAILABLE



700mm

700mm

MRP	PART NO.	SPECIFICATIONS
	WP-3118	LCV CHASIS BUS 12V/24V RADIAL KIT WIPER SYSTEM



APPROVED AS ORIGINAL EQUIPMENT BY LEADING INDIAN & OVERSEAS VEHICLE MANUFACTURERS



#### WIPER ARMS (TUBULAR 10mm HST PIPE SERIES)

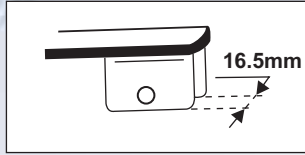

**WIPER ARM  
CLAMP INNER  
WIDTH**

MRP	PART NO.	SPECIFICATIONS
	WP-1132TCP	LUXURY BUS 24"
	WP-1132TCA	LUXURY BUS 27"
	WP-1132TCB	LUXURY BUS 30"
	WP-1132TCC	LUXURY BUS 32"



#### WIPER ARMS (FLAT THIN PATTI 9.50mm X 3mm SERIES)

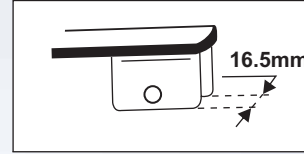

**WIPER ARM  
CLAMP INNER  
WIDTH**

MRP	PART NO.	SPECIFICATIONS
	WP-1132TA	LUXURY BUS 18"
	WP-1132TB	LUXURY BUS 21"
	WP-1132TC	LUXURY BUS 24"



#### WIPER ARMS (FLAT THICK PATTI 12mm X 4mm SERIES)

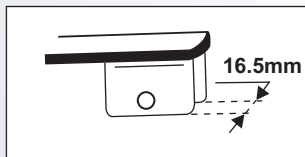

**WIPER ARM  
CLAMP INNER  
WIDTH**

MRP	PART NO.	SPECIFICATIONS
	WP-1132TS	LUXURY BUS 28"
	WP-1132TSA	LUXURY BUS 30"
	WP-1132TSB	LUXURY BUS 32"
	WP-1132TSC	LUXURY BUS 34"
	WP-1132TSD	LUXURY BUS 36"



#### WIPER ARMS (BAYONET FIT 9.5mm X 2.5mm SERIES)

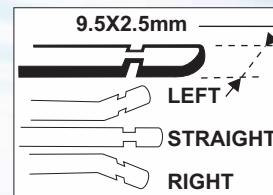

**WIPER ARM  
ROD WIDTH  
DIMENSION**

MRP	PART NO.	SPECIFICATIONS
	WP-1132A	TRUCK/BUS 15"
	WP-1132B	TRUCK/BUS 18"
	WP-1132C	TRUCK/BUS 21"
	WP-1132D	BUS 24"





#### WIPER ARMS (TWIN PIPE SERIES)

WIPER ARM  
CLAMP INNER  
WIDTH

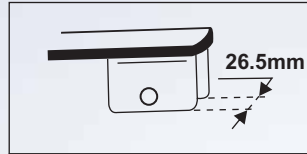

MRP	PART NO.	SPECIFICATIONS
	WP-1299VR	VOLVO B7R / B9R / B11R (CHINESE WIPER SYS)M12
	WP-1299VL	VOLVO B7R / B9R / B11R (CHINESE WIPER S YS)M12
	WP-1299CR	VOLVO B7R / B9R / B11R (DOGA WIPER SYS) M10
	WP-1299CL	VOB7R / B9R / B11R (DOGA WIPER SYS) M10
	WP-1299SR	SCANIA INTERLINK / MULTI-AXLE M10
	WP-1299SL	SCANIA INTERLINK / MULTI-AXLE M10
	WP-1290	TWIN PIPE STD FIT RH M10
	WP-1290A	TWIN PIPE STD FIT LH M10
	WP-1291	TWIN PIPE STD FIT RH M12
	WP-1291A	TWIN PIPE STD FIT LH M12

#### PENTOGRAPH 9mm X 4mm



WIPER ARM  
CLAMP  
INNER  
WIDTH

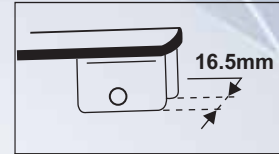

#### WIPER ARM PENTOGRAPH 9mm X 4mm

MRP	PART NO.	SPECIFICATIONS
	WP-1165	SEMI LUXURY BUS 24"
	WP-1165A	SEMI LUXURY BUS 26"
	WP-1165B	SEMI LUXURY BUS 28"

#### WIPER ARM PENTOGRAPH 12mm X 4mm

MRP	PART NO.	SPECIFICATIONS
	WP-1285	LUXURY BUS 28"
	WP-1285A	LUXURY BUS 30"
	WP-1285B	LUXURY BUS 34"

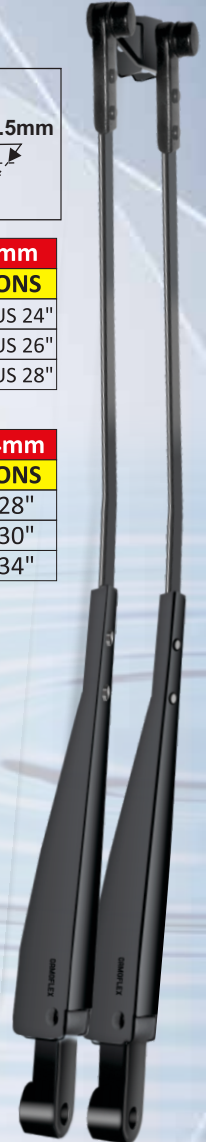

#### WIPER ARMS (TWIN FLAT PATTI 12mm X 4mm SERIES)

WIPER ARM  
CLAMP INNER  
WIDTH

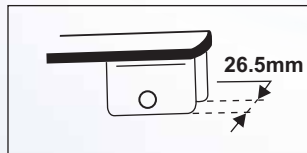

MRP	PART NO.	SPECIFICATIONS
	WP-1177CFR	ACGL COMFORT RHD M10
	WP-1177CFL	ACGL COMFORT RHD M10
	WP-1117	MARCOPOLO LPO1924 (DIMS/DTC) M10
	WP-1117A	MARCOPOLO LPO1924 (DIMS/DTC) M10
	WP-1118	MARCOPOLO LPO1924 LATEST(DIMS/DTC)M10
	WP-1118A	MARCOPOLO LPO1924 LATEST(DIMS/DTC)M10
	WP-1292	STANDARD FIT RH M10
	WP-1292A	STANDARD FIT LH M10
	WP-1293	STANDARD FIT RH M12
	WP-1293A	STANDARD FIT LH M12

AUTHORISED STOCKIST/DISTRIBUTOR/DEALER:-

Manufactured By:  
Allied Spares & Auto Parts Mfg Co. Pvt Ltd.  
'Camoflex House', 1709A, Phase 3,  
G.I.D.C., Vapi - 396 195. Gujarat, India.  
Landline: +91 77384 40000  
Customer Care: +91 22 2385 3737  
URL: [www.camoflexindia.com](http://www.camoflexindia.com)  
E-Mail: [enquiry@camoflexindia.com](mailto:enquiry@camoflexindia.com)

NAMES & BRAND NAMES OF VEHICLES ARE USED FOR REFERENCE PURPOSE ONLY.



APPROVED AS ORIGINAL EQUIPMENT BY LEADING INDIAN & OVERSEAS VEHICLE MANUFACTURERS